

RS-WMB, RD-WMB Wallbus Room Sensors and Displays

RS-WMB, RD-WMB



Description

The RS-WMB and RD-WMB series of room sensors and displays are designed for mounting on a standard electrical back box. They include a temperature sensor with versions which also include humidity and CO₂ sensors. The RD-WMB has a monochrome backlit LCD display with setpoint, override, and fan speed control.

They are designed to operate with Trend IQ4 and IQeco controllers. They connect to the controller by a two wire polarity independent wall bus which carries both data and power.

Note: RD-IQ and RD-IQL are covered by separate data sheets.

Features

- Single power/data connection to controller reduces wiring
- Temperature sensing plus versions with humidity and/or CO₂
- Temperature and humidity versions also output dew point
- Operates in either °C or °F

RD only

- Backlit LCD display with fan speed, occupancy, temperature, humidity, CO₂, and setpoint displays
- Setpoint, fan speed, and occupancy override controls.
- Display of Outside Air Temperature value from controller

Physical

The adjacent diagram shows the RD-WMB. The RS-WMB has the same external dimensions, but does not have the display and buttons.

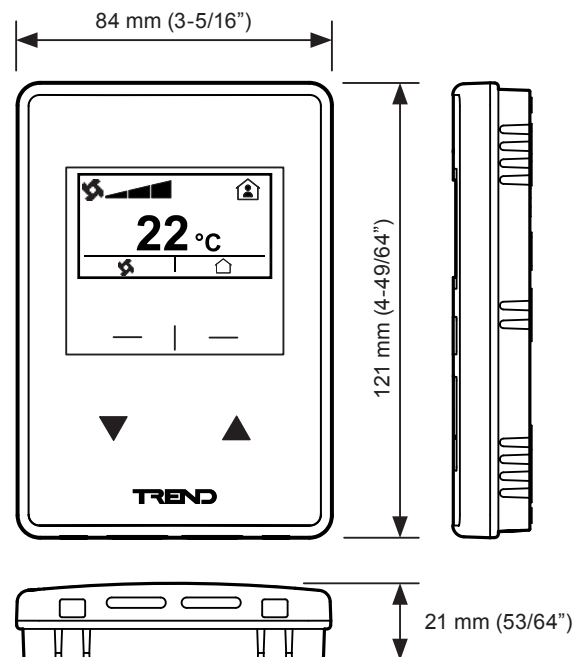

FUNCTIONALITY

There are two main units, the RS-WMB and the RD-WMB.

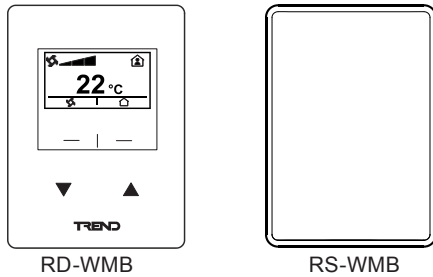

Both units include a temperature sensor and can output the temperature in either °C or °F. There are versions which include humidity and/or CO₂ sensors. Versions with temperature and humidity sensors will also calculate dew point and make it available to the controller.

The RD-WMB has an LED display and four control buttons. It enables the setpoint to be displayed and adjusted locally. It also allows the display and adjustment of fan speed and occupancy. The fan button can also be configured to perform adjustment without displaying the fan speed icons (e.g. for controlling other equipment such as window blinds). The values from the controller that the RD-WMB can display and change are fixed, but will only be enabled if set up in the controller.

Both RS-WMB and RD-WMB connect to an IQeco or IQ4 via its wallbus connector. This two wire connection carries both data and power.

DISPLAY AND BUTTONS (RD-WMB only)

The RD-WMB's front panel contains a backlit LCD matrix display and buttons. It is divided into two main areas:

Main Display
Buttons

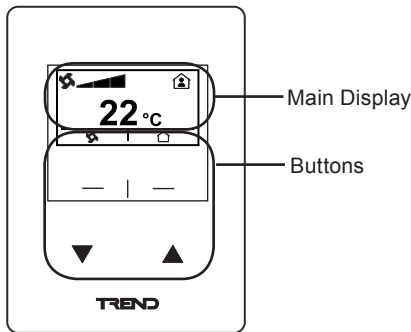

Main Display

By default the Room Temperature is displayed but it can also show Temperature Setpoint, Humidity, CO₂ concentration, and Outside Air Temperature according to which options have been set up in the Settings Menu, and what is supplied by the controller strategy. There are icons to display fan state, and occupation status if they are available from the controller:

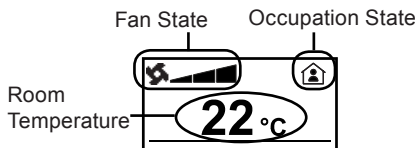

The icons shown on the display are shown in the table below:

Icon	Description
	Temperature setpoint

Icon	Description
	Room temperature
%RH	Humidity
CO2	CO2 concentration
	Outside temperature
	Indicates an unoccupied status.
	Indicates an occupied status.
	For single speed fan indicates ON For multi-speed fan used in conjunction with icons below to indicate fan status.
AUTO	Indicates multi-speed fan is in automatic control.
OFF	Indicates multi-speed fan manual control speeds.
(Low)	
(Medium)	
(High)	

Buttons

The RD-WMB has two areas used as buttons:

Functions Buttons
Decrease/Increase Buttons

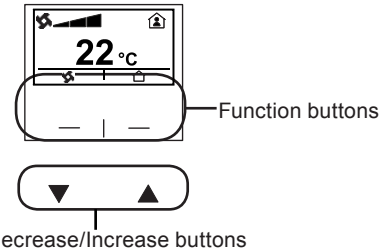

Function Buttons

The RD-WMB has two function buttons which adopt the function indicated by the icon above them.

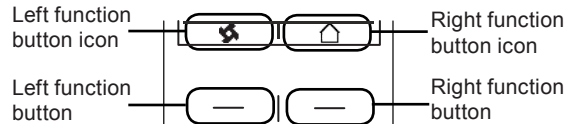

In the normal configuration shown above, the left button will select manual fan control, and the right button, manual occupation override.

Icon	Description
	Override fan / clear fan override.
	Override occupation while in automatic control.
	Clear occupation override while overridden
	'Exit' to previous screen
	Edit
	Accept change

Each function button can be removed from the display if it is not required using the Settings Menu or by configuring the controller (IQeco v2.3 or greater, or IQ4 only).

Pressing the two function buttons simultaneously and holding down for 5 seconds will cause the unit to enter Settings Menu.

Fan button: Pressing the fan button () will allow the user to override the fan speed control.

The way the fan operates is dependent on the type of fan control set up in the controller. For a 2 position fan, (OFF) indicates the fan is off, and (ON) indicates the fan is on, pressing the fan button toggles the fan state. For a multi-position fan, the first press switches the fan off, and subsequent presses step through the available fan speeds (e.g. low, medium, high), and the next press sets it to AUTO. The manual fan off condition is shown by OFF. It is possible to configure the strategy to override the fan button control.

Occupation override button: Pressing the occupation override (O) button will override the occupation state. The button icon will change to (O) to indicate that occupation is in manual override. Pressing the button again will return the occupation to automatic control indicated by the O icon. The current occupation state will be indicated on the Main display as shown above (if the controller strategy is set up appropriately).

Decrease (V) or Increase (A) Buttons

During normal operation pressing the decrease or increase buttons will display the setpoint adjustment screen (if not displayed by default), and they can then be used to change the setpoint. The (checkmark) button is used to confirm the change; (X) is used to cancel it.

'More' Display Mode: Pressing the decrease and increase buttons simultaneously will cause the RD-WMB to enter the 'More' Display Mode. The choice of items to be shown in the 'More' Display Mode can be selected in the Settings Menu. If all items are selected, pressing either decrease or increase will step through the following in the appropriate direction.

Icon	Read/Write	Units	Description
(edit)	Editable	°C or °F	Change temperature setpoint using (edit) and decrease/increase buttons.
(down arrow)	Read only	°C or °F	Displays temperature
(water drop)	Read only	%RH	Displays humidity
CO ₂	Read only	ppm	Displays CO ₂ concentration
(up/down arrow)	Read only	°C or °F	Displays outside air temperature from controller

Where the item is editable, one of the function keys is labelled (edit). Selecting (edit) enables the value to be changed using the decrease/increase keys. One of the function keys is now labelled (checkmark) so that when the editing is finished selecting (checkmark) will accept the new value and return to 'More' Display Mode.

Settings Menu: When in the Settings Menu these buttons are used to scroll up and down the menus and set values.

NORMAL OPERATION

Startup Reset

The unit will perform a reset cycle when power is applied. The RD-WMB will first display the Trend start up page followed by a page showing the unit firmware version and wallbus address. If communications with the controller are unsuccessful for at least 3 to 6 minutes the RD-WMB screen will display 'ERR' (error).

Illumination state (RD-WMB only)

By default the display's backlight will be off. Pressing any button will turn on the backlight. About 1 minute after the last button is pressed the backlight will turn off.

HARDWARE

Enclosure

The enclosure consists of a plastic back plate with a plastic clip-on main module. The back plate has several mounting holes enabling it to be used with a standard UK electrical back box, a standard US or Danish utility conduit box, or 60 mm wall outlet box (dry lining wall boxes are not recommended as they prevent flush fitting). Space must be left around the unit for airflow and access to remove the main module.

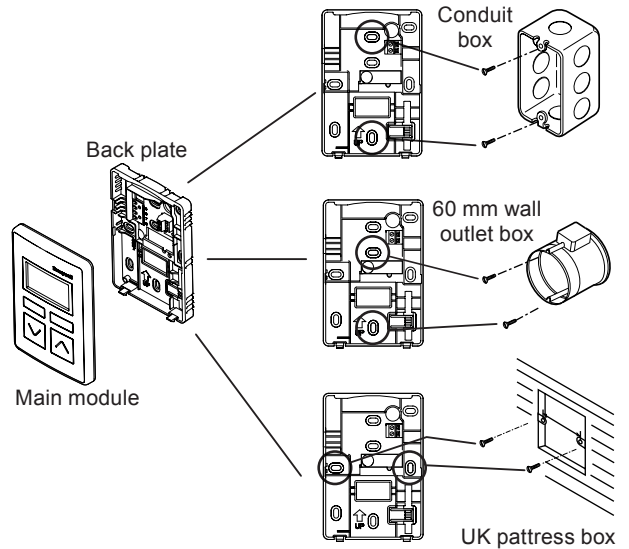

Input Power Supply

The power for the unit is supplied from the controller via the wallbus.

The IQeco can accommodate one RS-WMB or RD-WMB. The IQeco prior to v2.3 does not support the RS-WMB/RD-WMB CO₂ sensor (as included in TxC variants).

Note: For IQeco31, 32, 35, 38 the available wallbus current is restricted - see IQeco31, 32, 35, 38 Data Sheet (TA201176).

The IQ4 can accommodate more than one wallbus device providing the wallbus is able to provide enough power. The user must budget for the full wallbus 50 mA current.

Power requirements:

Version	Percentage of full current	Maximum number on wallbus*
RS-WMB-T, -TH	9%	10
RS-WMB-TC, -THC	18.2%	5
RD-WMB-T, -TH	12.8%	7
RD-WMB-TC, -THC	20.8%	4

*Maximum number with all RS-WMB, RD-WMBs of same type with 50 mA full current available from IQ4.

Backup

The Settings Menu settings are stored in non-volatile memory (EEPROM).

Display

The RD-WMB has a backlit LCD monochrome matrix display.

Communication

The RS-WMB, RD-WMB connects to the controller's wallbus port using two polarity independent wires - See the RS-WMB, RD-WMB Installation Instructions (TG201349). For maximum distance from the controller to the farthest wallbus device see table in specification section.

Address Switch

The RS-WMB, RD-WMB has a wallbus address switch which is supplied with the switch in the binary zero (default) position. This position sets the unit's wallbus address to the address defined in the Settings Menu (default = 2). For RD-WMB it should be left in this position.

For use with the IQeco, which can only have one wallbus device, the address switch should remain set to binary zero (address = 2).

If there is more than one device on the wallbus (i.e for IQ4), the unit's address may need to be changed (range 2 to 15). For an RD-WMB this can be done from the Settings Menu. For an RS-WMB this must be done by adjusting the address switch. The Wallbus Interface module's address must be set the same as its RS-WMB, RD-WMB for communications to succeed.

Note: Although the address range is 2 to 15, the number of wallbus devices connected to the controller will be limited by the controller's wallbus supply - see Input Power Supply.

FIRMWARE

The firmware in the RS-WMB, RD-WMB controls its basic functionality (e.g. what is displayed, the results of pressing the buttons).

Settings Menu (RD-WMB only)

The Settings Menu enables changes to be made to the way the RD-WMB operates. Access to the Settings Menu is protected by a 4 digit PIN. The following functions can be stepped through in the appropriate direction using the decrease/increase buttons.

WMB ADDRESS (editable): This is the address of the RD-WMB on the wallbus (default - 2). The address can be changed from here if the address switch is set to zero - see Address Switch.					
SETPOINT TYPE (editable): Specifies whether the temperature setpoint is displayed as a number or a graphic.					
<table border="1"> <tr> <td>NUMERICAL</td> <td></td> </tr> <tr> <td>GRAPHICAL</td> <td>? </td> </tr> </table>		NUMERICAL		GRAPHICAL?
NUMERICAL					
GRAPHICAL?				
HOME SCREEN (editable): Specifies what is displayed on the home screen. These values will only be displayed if supplied by the controller.					
OUTSIDE TEMP	The home screen displays outside air temperature.				
TEMP SETPOINT	The home screen displays temperature setpoint.				
TEMPERATURE	The home screen displays room temperature.				
HUMIDITY	The home screen displays humidity.				
CO₂	The home screen displays CO ₂ concentration.				
BLANK SCREEN	The home screen displays a blank screen.				
SCROLLING SCREEN	The home screen scrolls through the available values: Temperature, Humidity, CO ₂ concentration, Outside Air Temperature.				
FIRMWARE REV (read only): The firmware revision number.					

Editable items can be changed in the same way as items in the 'More' display. Certain editable parameters may be set from the Settings Menu and the controller in which case changes made from the Settings Menu may be overridden by the controller.

The exit icon  button returns to the Home screen.







Security (RD-WMB only)

The unit is pre-programmed with a 4 digit PIN to protect entry to the Settings Menu.

Fan Configuration (RD-WMB only)

The fan can be operated in one of seven modes (0 to 6).

On power up of the RD the fan configuration mode is set by the controller according to PV 2003 for IQ4, and the 'Fan Configuration' parameter (f) of I/O module 2 for IQeco. These are set to a value, 0 to 6 as listed below.

Mode	Description
0	No fan on home screen. The fan icon  is not shown. The Fan function button is not shown on the Home screen.
1	2 position fan (Off/On). The fan icon  indicates the fan is on,  OFF) indicates the fan is off. The Fan function button sends values 0=OFF, 255=ON.
2	3 position fan (Off, On, Auto). The fan icon  indicates the fan is on,  OFF) indicates the fan is off,  AUTO) indicates the fan is in auto mode. The Fan function button sends values 0=OFF, 1=ON, 4=AUTO
3	4 position fan (Off, 1, 2, 3). The Fan function button sends values 0=OFF, 1=Low, 2=Medium, 3=High. See appropriate rows in table in mode 4 below:
4	5 position fan (Off, 1, 2, 3, Auto). Fan function button sends values 0=OFF, 1=Low, 2=Medium, 3=High, 4=AUTO.
5	4 position blind (0, 1, 2, 3). The state is not indicated by the icons. The value sent from the RD-WMB on each Fan function button press cycles between 0, 1, 2, 3. It can be used to control another device; for example, it can be used to control a window blind (0=static, 1=raise, 2=static, 3=lower).
6	5 position blind (0, 1, 2, 3, 4). The state is not indicated by the icons. The value sent from the RD-WMB on each Fan function button press cycles between 0, 1, 2, 3, 4. It can be used to control another device.

CO₂ Concentration

An RD-WMB-Txx can display CO₂ concentration supplied by either an IQ4 or IQeco controller from a separately connected CO₂ sensor.

For RS-WMB-TxC and RD-WMB-TxC, the integral CO₂ concentration sensor can only be read (and hence displayed on the RD) by an IQeco v2.3 or greater or an IQ4 controller.

Process Variables (PVs)

Information is transferred between the controller and the RS-WMB, RD-WMB using Process Variables (PVs). This is true for both IQeco and IQ4. However, for IQeco (prior to v 2.3), the relationship between strategy modules and the PVs is fixed, and all that is required is to make the appropriate modules available in the strategy - see "Main Display" on page 2. This method is also supported by IQeco v2.3 or greater so that strategies created for the earlier IQeco are supported. If this method were used, a CO₂ sensor integral to the display would not be able to be read by the controller.

IQeco v 2.3 or greater can use, and IQ4 will use, a more flexible method where the Wallbus Interface module is configured to make the links - see "Use with IQ4 or IQeco (v2.3 or greater)" on page 6.

Each PV is either an input to the RS-WMB, RD-WMB, an output from the RS-WMB, RD-WMB or an input/output.

For the RS-WMB, RD-WMB's internal values (e.g. temperature, humidity, CO₂ concentration and dewpoint), the values are outputs from the RS-WMB, RD-WMB and the displayed values on the RD-WMB are separate inputs to the RD-WMB.

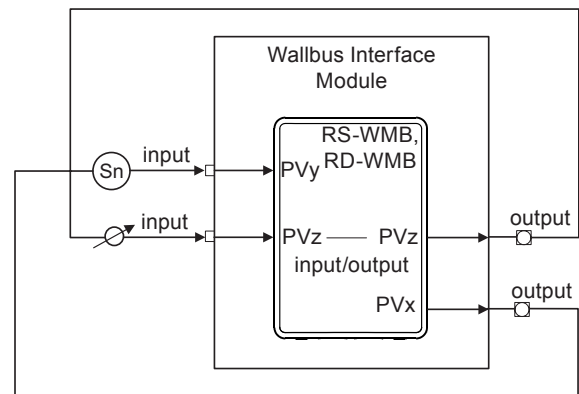

This can be seen in the diagram where PVx is the output from the RD-WMB which is connected to a sensor module in the strategy. The sensor's output is then sent back to the RD-WMB for display (PVy). This enables the strategy to change the value before display (e.g. apply an offset).

Some values are both input and output (e.g. setpoint). In the example the input and output of the knob are both connected to PVz. If the value is changed in the RD-WMB it is written to the knob, and if the value of the knob is changed (e.g. by text comms) the value is written to the RD-WMB, the last one changed becomes the current value.

The table below lists the PVs.

PV	Variable	Description	Input/Output	*Override Settings Menu
1001	Temperature	The RS-WMB, RD-WMB temperature sensor reading.	Output	No
1002	Humidity	The RS-WMB, RD-WMB humidity sensor reading.	Output	No
1003	Dew point	The dew point calculated in the RS-WMB, RD-WMB.	Output	No
1004	Firmware version	RS-WMB, RD-WMB's firmware version	Output	No
1005	Factory configuration	Numeric code for RS-WMB, RD-WMB configuration e.g 110:TH	Output	No
1006	Local CO ₂	The RS-WMB, RD-WMB CO ₂ concentration sensor reading	Output	No
2001	Temperature configuration	Defines units displayed for temperature and setpoint, and used for temperature measurement and dew point calculation. 1 = °C, 2 = °F	Input	No
2002	Display temperature	Room temperature to be displayed on RD-WMB.	Input	No
2003	Fan Configuration (Left function button)	Defines what type of control the left function button supports (modes 0 to 6) - see "Fan Configuration (RD-WMB only)" on page 4. 0 = No button 1 = 2 position (Off/On) -binary function 2 = 3 position fan (Off, On, Auto) - enumerated 3 = 4 position fan (Off, 1, 2, 3) -enumerated 4 = 5 position fan (Off, 1, 2, 3, Auto) - enumerated 5 = 4 position blind (Off, 1, 2, 3) -enumerated - no icon 6 = 5 position blind (Off, 1, 2, 3, Auto) - enumerated - no icon	Input	No
2004	Occupation State	Occupation state 0 = Occupied 1 = Unoccupied 255 = No button	Input	No
2005	Setpoint high limit	Maximum value the temperature setpoint can be set to.	Input	Yes
2006	Setpoint low limit	Minimum value the temperature setpoint can be set to.	Input	Yes
2007	Display humidity	Humidity to be displayed on RS-WMB, RD-WMB.	Input	No
2008	Setpoint Enable	Enables temperature setpoint to be changed from the RD-WMB. Disabling it allows setpoint value to be displayed without being able to change it. 0 = Disable, 1 = Enable (default)	Input	No
2009	Fan Enable	Enables fan setting to be changed from the RD-WMB. Disabling it allows fan status to be displayed without being able to change it. 0 = Disable, 1 = Enable (default)	Input	No
200A	Override Enable	Enables occupation to be overridden from the RD-WMB. Disabling it allows occupation status to be displayed without being able to change it. 0 = Disable, 1 = Enable (default)	Input	No

PV	Variable	Description	Input/Output	*Overwrite Settings Menu
200B	Display CO ₂	The value of CO ₂ from the controller to be displayed on the RD-WMB.	Input	No
200C	Display Outdoor Temperature	The value of outside air temperature from the controller to be displayed on the RD-WMB.	Input	No
6001	Fan state (Left function button)	This is the current state of the left function button. It can be set to any value within the range defined by left button configuration (PV2003).	Input/Output	Yes
6002	Override state (Right function button)	This is the current state of the right function button. It can be set to 0 or 1. If PV2004 (Occupation State) is set to 255, this will be ignored. For occupation override these are: 0 - automatic, 1 - override.	Input/Output	Yes
6003	Setpoint	The current value of temperature setpoint. It can be set in the range between Setpoint low limit (PV2006) and Setpoint high limit (PV2005).	Input/Output	Yes
90C	Display	Adjusts what is displayed: 0 = No Display 1 = Temperature 2 = Humidity 3 = CO ₂ 4 = Setpoint 5 = Cycle through measured variables	Input	Yes
906	Setpoint	It controls how the setpoint is displayed when PVID 90C set to 4 (setpoint): 0 = Numeric 1 = Graphical	Input	Yes

*Those PVs tagged 'Yes' will overwrite the values set by the Settings Menu when sent from the controller. For input/output PVs, as well as controller values overwriting the Settings Menu values, the Settings Menu values will overwrite the controller values. As explained above this is normally done in the strategy by connecting the input and output from the interface module to a knob or switch. The last change (either from controller or Settings Menu) will set the current value.

CONFIGURATION

Use with IQ4 or IQeco (v2.3 or greater)

If the RS-WMB, RD-WMB is to be used with an IQeco (V2.3 or greater) or IQ4, the strategy to interface with the device must be configured using IQSET. This can be done in two ways:

Using the IQSET strategy block
Manual configuration

If upgrading an existing IQeco custom strategy for use with the RS/RD (e.g. to gain use of CO₂ sensor) see IQeco Strategy Upgrade for RS/RD-WMB Information Sheet (TP201385).

Note: Whichever method is used it should be repeated for each RS or RD added to the wallbus.

Using the IQSET strategy block (recommended):

- Add the IQSET Strategy Block to the strategy. The strategy blocks are located in the 'Standard Block' section of the Strategy Library in the 'WMB Room Modules' section. There is a separate section for RS and RD, each section has 4 blocks, one block for each product version (-T, -TC, -TH, -THC).
- Set the Wallbus Interface module's 'Address' parameter to the RS-WMB, RD-WMB's address on the Wallbus (default is 2.)
- Ensure that the Wallbus Interface module's inputs and outputs are linked to the required modules in the strategy.

Important: When using the strategy block (as explained above) some PVs write their value to the RD-WMB and will overwrite changes to that PV made in the RD-WMB's Settings Menu. If this is not required, remove the PV from the Wallbus Interface module's inputs. See "Process Variables (PVs)" on page 5 for details.

Adding the strategy block will automatically add the Wallbus Network module, and create an instance of the Wallbus Interface module.

The strategy block configures the inputs and outputs of the Wallbus Interface module as detailed below. The following details apply to the RD-WMB-THC; the other strategy blocks are subsets of this one:

- Address 2
- Room temperature, humidity, dew point, and CO₂ concentration output to strategy from RS/RD and fed back for display to RD via sensor modules.
- Fan configured as a 5 position fan (Off, 1, 2, 3, Auto) - (4)
- Temperature setpoint high limit 80 - linked to 'Setpoint Highlimit' knob
- Temperature setpoint low limit 0 - linked to 'Setpoint Lowlimit' knob
- Temperature setpoint can be changed from controller 'Setpoint' knob or RD
- Fan state can be changed from controller 'Fan State' knob or RD.
- Occupation can be overridden from controller 'Override State' switch or RD
- Occupation state output to RD
- °C used for temperature and setpoint units

This configuration should be suitable for most applications. If different functionality is required the strategy will need to be modified after the strategy block has been added.

Manual configuration:

- Add the Wallbus Network module to the strategy (default values will be suitable).
- Add a Wallbus Interface module to the strategy.
- IQSET the Wallbus Interface module's 'Address' parameter to the RS-WMB, RD-WMB's address on the Wallbus.

- Set up the Wallbus Interface module's input and output connections to specify the PV (PV Index) in the RS-WMB, RD-WMB that they are to be linked to as well as their other parameters. The RS-WMB, RD-WMB's PVs are described in "Process Variables (PVs)" on page 5.
- Link the Wallbus Interface module's inputs and outputs to the required modules in the strategy.

For details of the Wallbus Network and Wallbus Interface modules see the IQeco Configuration Manual (TE201089) or IQ4 Configuration Manual (TE201263). For details of using IQSET - see the IQSET Manual (TE200147).

COMPATIBILITY

The RS-WMB, RD-WMB is compatible with IQeco with firmware version 2 or greater, and with the IQ4 firmware version 3.30 or greater. IQSET v7 is required to configure IQ4 for use with RS-WMB, RD-WMB. IQSET v7.04 is required to configure IQeco v2.3 or greater for use with RS-WMB, RD-WMB.

IQeco standard strategies can use the RS-WMB, RD-WMB without any further engineering.

Use with IQeco prior to v2.3

Note: This method is also supported by IQeco v2.3 or greater so that existing strategies are still compatible.

Connecting the RS-WMB, RD-WMB to the IQeco makes additional I/O channels available to the controller. The RS-WMB, RD-WMB is considered to be an additional I/O module (I/O module 2) of WMB display type. Configuring this module gives additional I/O channels (the number being dependent on the RS-WMB, RD-WMB type), and some fixed mapping to the controller variables. This method is described fully in the IQeco Configuration Manual (TE201089).

There is a special set of standard strategies for using the RS-WMB, RD-WMB with an IQeco v2.3 or greater. These use the more flexible method of interfacing (also used by IQ4) described on p6. This method enables the IQeco to be used with RD-WMB-TxC or RS-WMB-TxC (i.e. to use the display's CO₂ sensor).

FIELD MAINTENANCE

The RS-WMB and RD-WMB require no routine maintenance.

DISPOSAL

COSHH (Control of Substances Hazardous to Health - UK Government Regulations 2002) ASSESSMENT FOR DISPOSAL OF RS-WMB, RD-WMB. No parts affected.

RECYCLING

All plastic and metal parts are recyclable. The printed circuit board may be sent to any PCB recovery contractor to recover

some of the components for any metals such as gold and silver.

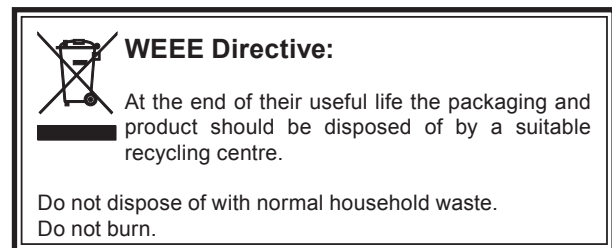

INSTALLATION

The RS-WMB, RD-WMB should be mounted on a standard electrical back box or front panel using two screws. The installation involves:

- Mounting unit
- Connecting to controller for power and data.
- Configuring controller
- Configuring RS-WMB, RD-WMB
- Testing operation

The installation and configuration procedure is covered in the RS-WMB, RD-WMB Installation Instructions (TG201349).

ORDER CODES

RS-WMB-T	Room Sensor for use with IQ4 or IQeco with a wallbus connection. It has local temperature sensor,
RS-WMB-TH	Room Sensor for use with IQ4 or IQeco with a wallbus connection It has local temperature sensor, local humidity sensor, and dew point output.
RS-WMB-TC	Room Sensor for use with IQ4 or IQeco with a wallbus connection. It has local temperature sensor and local CO ₂ concentration sensor.
RS-WMB-THC	Room Sensor for use with IQ4 or IQeco with a wallbus connection. It has local temperature sensor, local humidity sensor, local CO ₂ concentration sensor, and dew point output.
RD-WMB-T	Room Display for use with IQ4 or IQeco with a wallbus connection. It has local temperature sensor, setpoint control, occupation override, occupation status display, and fan speed control. It also has the ability to display CO ₂ concentration and outside temperature values from the controller.
RD-WMB-TH	Room Display for use with IQ4 or IQeco with a wallbus connection. It has local temperature sensor, local humidity sensor, dew point output, setpoint control, occupation override, occupation status display, and fan speed control. It also has the ability to display CO ₂ concentration and outside temperature values from the controller.
RD-WMB-TC	Room Display for use with IQ4 or IQeco with a wallbus connection. It has local temperature sensor, local CO ₂ concentration sensor, setpoint control, occupation override, occupation status display, and fan speed control. It also has the ability to display outside temperature values from the controller.
RD-WMB-THC	Room Display for use with IQ4 or IQeco with a wallbus connection. It has local temperature sensor, local humidity sensor, local CO ₂ concentration sensor, dew point output, setpoint control, occupation override, occupation status display, and fan speed control. It also has the ability to display outside temperature values from the controller.

SPECIFICATION

ELECTRICAL

Buttons	:(RD-WMB only) 4 buttons on front panel: 2 programmable function buttons and raise/lower buttons
Display	:(RD-WMB only) Backlit LCD matrix.
Communication	:WMB wallbus. Two wire bus for connection of display units to controller. Polarity independent. Maximum distance from the controller to the farthest wallbus device.

Quantity and type of device	Single twisted pair, non-shielded, stranded or solid		All Other
	18-22 AWG	24 AWG	18-24 AWG
*Up to 10	150 m (500 ft)	120 m (400 ft)	30 m (100ft)

*The number of devices which can be connected to the wallbus depends on which devices and which controller are used - see Input Power Supply on page 3.

Temperature Sensor	:Solid state
Temperature range	:-40 °C (-40 °F) to +65 °C (+149 °F)
Temperature Accuracy Unit Sensing Element	:±1 °C at 25 °C (±1.8 °F at 77 °C) :±0.2 °C at 25 °C (±0.36 °F at 77 °C)
Humidity Sensor (-THx only)	
Humidity Range	:0 to 90 %RH
Humidity Accuracy	:±3 %RH from 20 to 80 %RH
CO ₂ Concentration Sensor (-TxC only)	
CO ₂ Concentration Range	:0 to 2000 ppm (RD will display up to 9999 ppm)

CO₂ Concentration Accuracy
 :±(30 ppm + 3% of measured value). Calibrated at factory. Uses automatic background calibration. No calibration required for the life of the product. Meets CEC Title 24 requirement of ±75 ppm accuracy at 600 ppm and 1000 ppm ambient levels. For proper CO₂ operation install only in places that see at least 4 hours of continuous unoccupied time per week.

Setpoint Control (RD-WMB only)
 :Increment or decrement by 0.5 °C (1 °F).

MECHANICAL

Dimensions	:84 mm (3 5/16") x 121 mm (4 9/64") x 21 mm (53/64") from electrical back box
Material	
Main module	:ABS
Back plate	:ABS
Weight	:103 gms, (0.23 lbs)
Protection	:IP30
Connections	:Polarity independent, 2 part connector with 2 screw terminals for 0.33 to 0.82 mm ² (22 to 18 AWG) cross section area cable.

ENVIRONMENTAL

Operating Temperature	:0 °C to 50 °C (32 °F to 122 °F)
Shipping Temperature	:-40 °C to 65.5 °C (-40 °F to 150 °F)
Approvals:	:CE, UL94-V0 plastic enclosure; FCC Part 15, Class B

Please send any comments about this or any other Trend technical publication to techpubs@trendcontrols.com

© 2017 Honeywell Technologies Sàrl, E&ES Division. All rights reserved. Manufactured for and on behalf of the Environmental & Energy Solutions Division of Honeywell Technologies Sàrl, Z.A. La Pièce, 16, 1180 Rolle, Switzerland by its Authorized Representative, Trend Control Systems Limited.

Trend Control Systems Limited reserves the right to revise this publication from time to time and make changes to the content hereof without obligation to notify any person of such revisions or changes.

Trend Control Systems Limited

Albery House, Springfield Road, Horsham, West Sussex, RH12 2PQ, UK. Tel:+44 (0)1403 211888 Fax:+44 (0)1403 241608 www.trendcontrols.com